



DC12

DOUBLE-COLUMN TYPE 5-AXIS
VERTICAL MACHINING CENTER



WE ARE AXILE

AXILE designs and builds agile smart 5-axis VMCs with leading automation solutions for manufacturers of complex parts and components.

“ We believe manufacturers shouldn’t have to choose between high-speed and high-performance 5-axis machines. ”

By combining sheer agility, digitalized intelligent automation, and a new standard of 5-axis machining, we’ve created an all-new approach:

Agile Smart Machining.

In short, our dedicated team of industry experts brings together ultra-high removal rates, pinpoint precision, and 24/7 automation and reliability within each and every AXILE 5-axis machine.

Our breakthrough design concepts and advanced proprietary technologies serve highly sophisticated manufacturers of complex parts and components for applications in aerospace, die and mold, medical, and general job shop, among others.

The AXILE service and support network spans nearly 50 countries, with more than 70 distributors across Asia, Europe, and the Americas, and a service center in Croatia.



CONTENTS

4 DC12 DOUBLE-COLUMN TYPE VMC

DESIGN CONCEPT

AGILITY

SPINDLE

CHIP MANAGEMENT

TOOL MANAGEMENT

ERGONOMICS

ACCURACY

14 STANDARD & OPTIONAL EQUIPMENT

16 CONTROL UNIT

17 TECHNOLOGIES

SMT™ - SMART MACHINING TECHNOLOGY

ART™ - INTELLIGENT MONITORING SYSTEM

20 MOTORIZED PALLET CHANGER

20 LAYOUT AND WORKSPACE

22 TECHNICAL DATA

DC12 DOUBLE-COLUMN TYPE VMC

The DC12 is the most robust VMC in AXILE's arsenal, perfectly suited for handling larger, lengthy workpieces. With a maximum table loading weight of 2.5 tonnes and maximum diameter of 2,200 mm X 1,200 mm, the DC12 takes on the larger, heavier parts common in the aerospace, power generation, and die and mold industries. Its double-column bridge construction allows for greater rigidity, as well as greater control over thermal deformation. As a result, the DC12 is capable of deep cuts and complex contouring while maintaining utmost precision.

With larger workpieces come more chips, meaning the DC12 features excellent chip removal efficiency, to prolong tool life and ensure no residual interference. Therefore, the DC12 delivers the high surface quality expected by leading manufacturers.

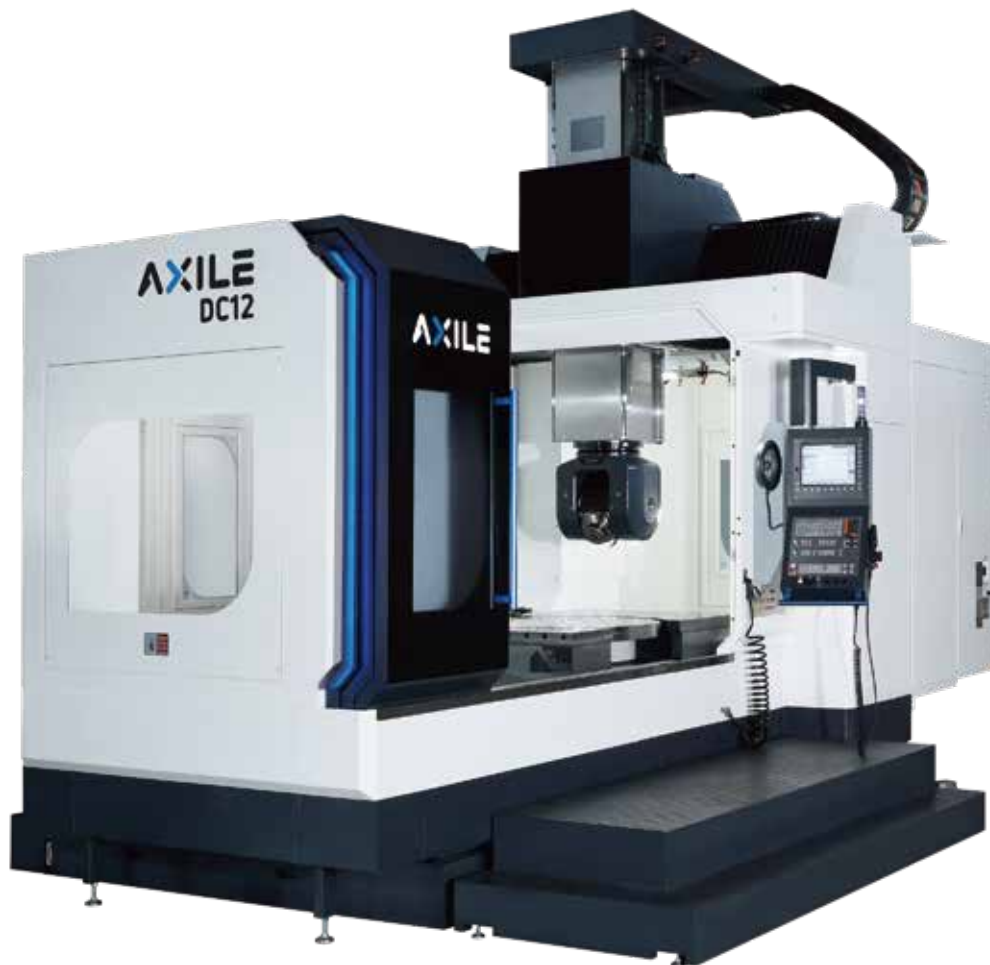

DESIGN CONCEPT

THE STRUCTURE

1

Spindle swiveling within the head and moved by Y & Z bridge axes

The swiveling spindle enhances tool accessibility to complex parts features

2

Bridge design

Same stability in all travels of X and Y axes
Excellent accessibility to working area

3

3-guided Y-axis carriage

Highest stability and accuracy even in roughing processes with high torque in spindle

4

4-guided Z-axis Box-in-Box RAM

Ensures highest rigidity of the long RAM to absorb the machining vibration

5

Massive bridge supported on a one-piece base

Best linear-axis geometry and long-term stability

6

All body made of high-quality casting

Homogeneous thermal behaviour
Optimal damping of machining vibrations

7

Integrated chip disposal channel directly under the table

Quick evacuation of chips for high chip volume machining



3-guideway Y-axis

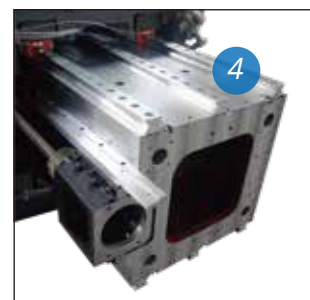

Box-in-Box RAM

AGILITY

LINEAR AXES

1

Direct driven servomotors (no belts/gears)

Best dynamic and minimal elasticity in the driving system

2

Linear scales with 0,1 μm resolution in X, Y and Z axes

Ensures best accuracy for ALL axes

Roller type linear guideways

Best high-feed movement and vibration damping

Pre-loaded double-nut ballscrews

Minimized backlash allowing high-feed movements



SWIVELLING-ROTARY AXES

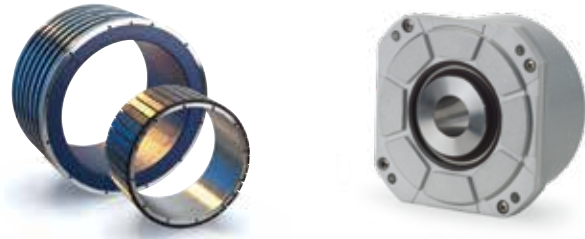

Integrated and ready-to-use hydraulic and pneumatic ports for the rotary C-axis table	Simplifying parts clamping process
Table: Torque motor-driven rotary axis (C)	Highest dynamics
Head: Dual torque motor-driven swiveling axis (B)	Highest accuracy
Swivelling head vs Rotary table	
Spindle A: B axis (HSK-A63/100) Torque S1 (Nm)	1100
Table A: C axis Torque S1 (Nm)	1940
Spindle C: B axis (HSK-A63/100) Torque S1 (Nm)	1158
Table B: C axis Torque S1 (Nm)	2000
Hydraulic brake	High-repeatability in 4+1x operation when using the brakes
High-resolution, direct absolute rotary measuring system	Zero-backlash and high accuracy



Swivelling B-axis head

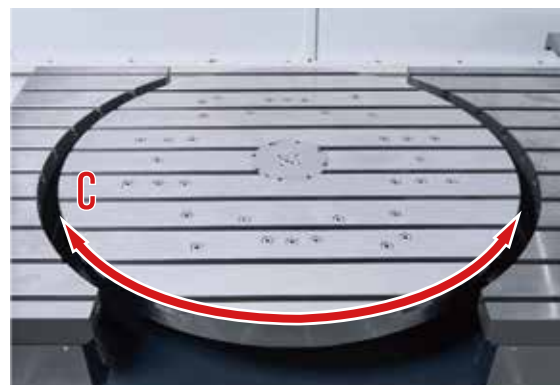

Rotary C-axis table

SPINDLE

HIGH-PERFORMANCE BUILT-IN SPINDLE SELECTION



Spindle A

- > 20.000 rpm > HSK A63
- > Power 45/45 kW (S1/S6-40%)
- > Torque 130/160 Nm (S1/S6-40%)

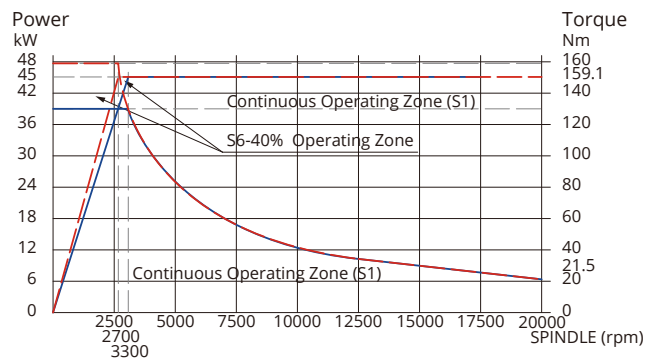

- > 16.000 rpm > HSK A100
- > Power 40/40 kW (S1/S6-40%)
- > Torque 150/180 Nm (S1/S6-40%)

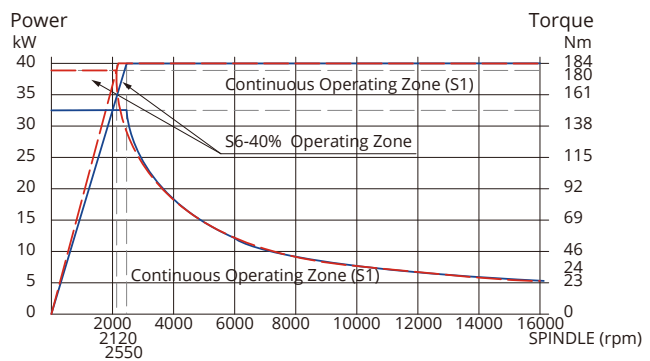



Spindle C

- > 20.000 rpm > HSK A63
- > Power 60/65 kW (S1/S6-40%)
- > Torque 120/151 Nm (S1/S6-40%)

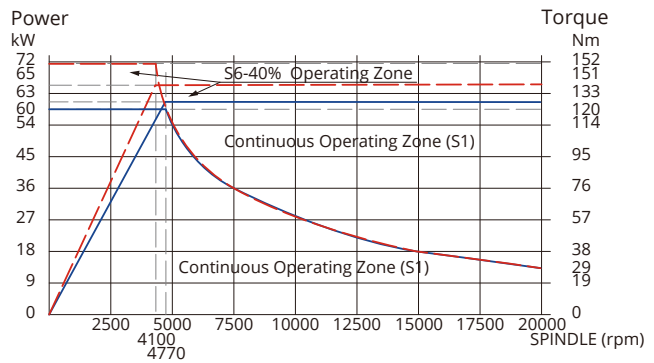

- > 16.000 rpm > HSK A100
- > Power 46/55 kW (S1/S6-40%)
- > Torque 174/241 Nm (S1/S6-40%)

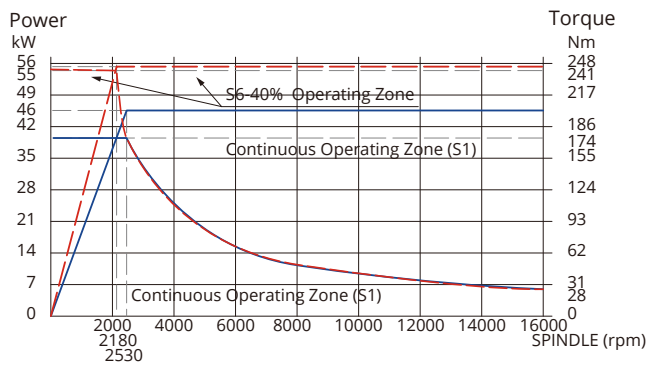

CHIP MANAGEMENT

FLUSHING CHIPS AWAY



There are two screw-type chip augers provided at both sides of the base

During cutting, the chips are delivered through chip augers to a chip conveyor for easy chip removal

- 1 Chip auger
- 2 Chip conveyor
- 3 4x coolant at spindle nose
- 4 Coolant through spindle
- 5 Air flushing
- 6 Chip wash down

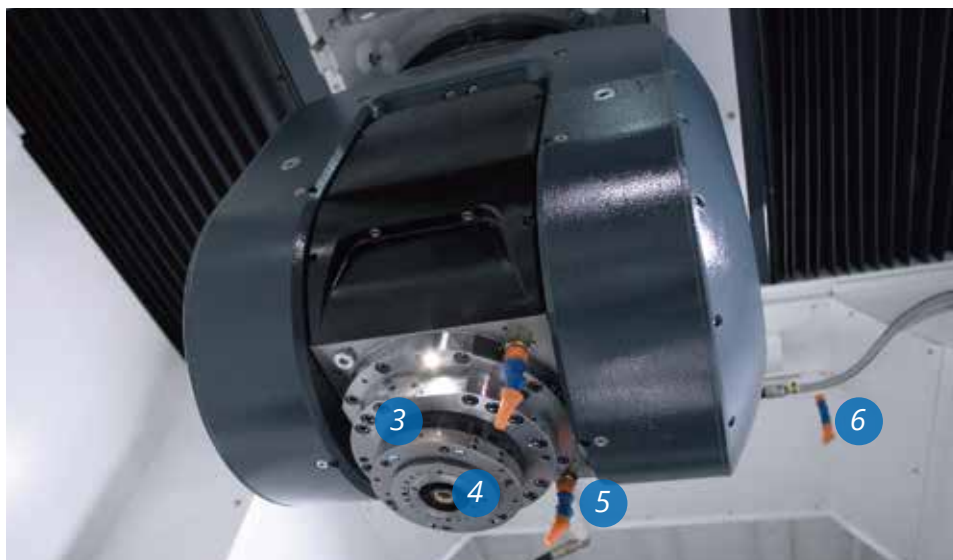

TOOL MANAGEMENT

TOOL MAGAZINE SELECTION FOR EVERY APPLICATION

1



2



1

Chain type ATC
 HSK-A63 tool shank: 90 or 120 tools
 HSK-A100 tool shank: 60 tools

Sister tools, complex parts and unmanned operation can be executed with no worries on the tool magazine capacity.

2

Matrix type magazine for HSK-A63 tools

Maximum tooling availability to reduce work preparation time and increase flexibility

Ideal configuration for high-tech job-shops and high-volume production companies

Tools are accessible from the back-left side of the machine and stored with an assisted drawer

Tools can be easily changed during automatic operation in the same area for machining supervision, CNC panel and workpiece loading and unloading.

Smart tool: interface panel is used to select the tool. When finished, the system checks whether all tool HSK-A63 holders are in the right position

Avoid human failures when manually change tool to spindle, protecting spindle and reducing down-time.

Chain-type magazine with 60, 90 or 120 tools capacity



ACCURACY

THE CORNERSTONE OF 5-AXIS MACHINING

Linear axes accuracy

Ballscrew's thermal growth

0.1 μ m resolution absolute linear scales in ALL axes

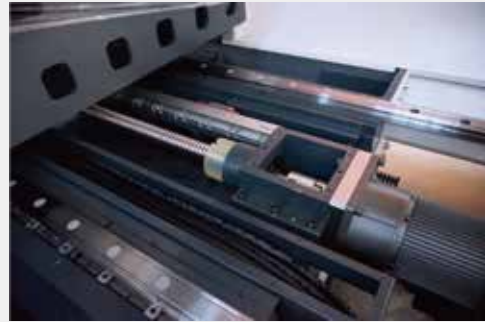

Rotary axes accuracy

Elasticity and backlash of driving system

Direct-driven torque motors with no backlash

Angular error is multiplied by the distance from rotary axis to machining point

+/- 5" accuracy absolute rotary scale feedback



Thermal control

Heat generated by spindle and torque motors

Spindle and torque motors are cooled with a water chiller close-circuit and a cooling unit



Linear-rotary axes relative positioning

The swivelling-rotary table might shift its relative position to the 3 linear axes by many reasons generating an increasing error in the part

CNC embedded compensating functions like Kinematics (Heidenhain), Kinematic chain (Siemens) and Tilted working plane indexing (Fanuc)



ERGONOMICS

ACCESSIBILITY TO WORKING AREA

Integrated roof for overhead crane loading and unloading

Large front door opening	Comfortable access to working area for workpiece preparation and supervision
Rotary table at same level as fixed table	Ergonomic loading and work preparation
Integrated roof to open ceiling working area	Easy loading and unloading of heavy and bulky workpieces by over head crane

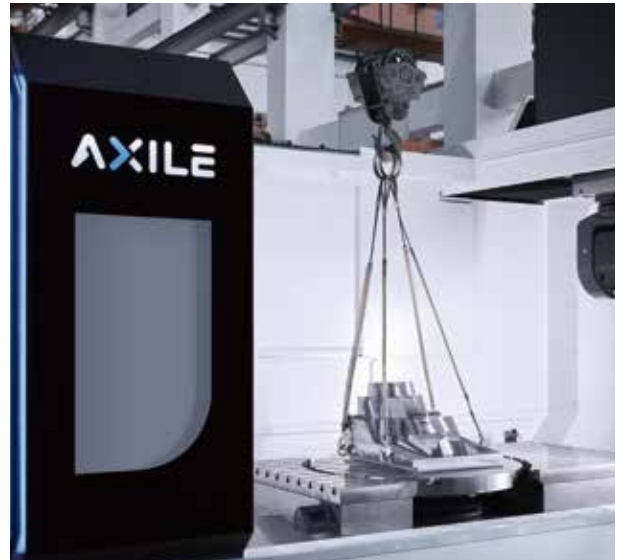

EASIER TOOLING MANAGEMENT AND MAINTENANCE



Tools are accessible from back of the machine	Tools can be easily changed during automatic operation
All necessary consumables are located together in the back of the machine	Easier routine maintenance for operator



Smart tool panel is used to select the tool and to check if all tool holders are in the right position when job is finished	Avoid human failures when manually change tool to spindle, protecting spindle and reducing down-time
---	--

STANDARD & OPTIONAL EQUIPMENT

High efficiency air conditioner

Electrical cabinet is maintained at stable temperature by using an air conditioner



Dual chip auger, chain type chip conveyor and CTS with bar pump and paper filter are standard equipments



U-type embedded in the table (for highest accuracy)

Tools are measured by an additional laser tool measurement, in different angles.



Automatic workpiece measurement (with probe, receiver and reference ball)

Automatic compensation of the rotary axis relative positioning:
Kinematics (Heidenhain), Kinematic chain (Siemens) and Tilted working plane indexing (Fanuc)

For accurate workpiece positioning or in-process measuring of some machining features.



Cooling unit:

- > CTS with 40 bar pump, paper filter and oil skimmer
- > CTS with 70 bar pump, paper filter, oil skimmer and coolant chiller
- > CTS with 70 bar pump, paper filter, oil skimmer, coolant chiller and programmable valve

Recommended for high aluminum or cast iron material



Work Platform

Allows workers easily approach the working area

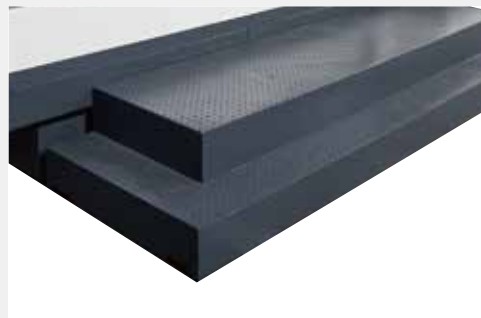

Spin window

Allows workers easily check the working area



CONTROL UNIT

A CONTROLLER FOR EVERY USER

Heidenhain TNC 640

- > Kinematics
- > Dynamic Collision Monitoring
- > Tool Center Point Management
- > Tilted the Working Plane

Heidenhain TNC 640

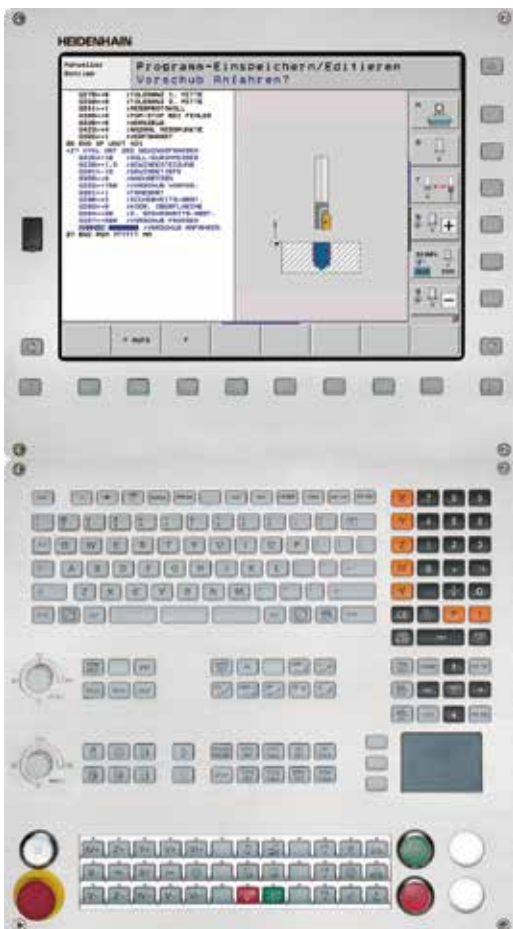

SINUMERIK ONE

- > Kinematics chain
- > Collision Avoidance
- > 5-axis transformation with tool orientation
- > Swivel the Coordinate System

Fanuc 31i-B5 plus

- > 3D Interference Check
- > High Speed Smooth TCP
- > Tilted Working Plane indexing

Sinumerik ONE



Fanuc 31i-B5 plus



TECHNOLOGIES

SMT™

SMART MACHINING TECHNOLOGY

As pioneers of advanced mechatronic systems with decades of R&D expertise, AXILE has taken 5-axis CNC machining to the next level. Our patented SMT™ (Smart Machining Technology) delivers groundbreaking compensation and calibration functionality for unrivaled cutting speeds and industry-leading accuracy, and more importantly, resolves the aforementioned issues created by thermal expansion.

With AXILE's SMT™ manufacturers can have it all. There's no longer the need to choose between speed and precision, meaning manufacturers can produce superior parts rapidly, while also securing total process reliability and long-term machining performance.



Axial Accuracy Control



- > **AXIAL THERMO MONITORING**
Integration of temperature sensors and thermal error model
- > **HIGH PRECISION**
Thermal induced positioning error compensation

Thermal Error Before and After Compensation

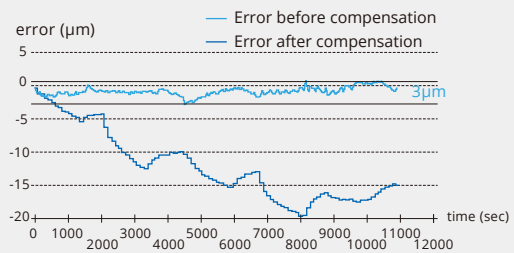

With thermal compensation system, the thermal error can be reduced from 20µm to 3µm.



Tool-tip Positioning Control

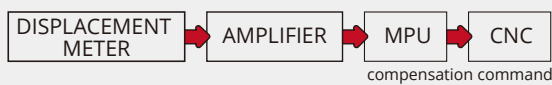

- > **HIGH ACCURACY**
Directly measuring expansion
- > **BETTER SURFACE FINISH**
5~6 times accuracy improved
- > **REAL-TIME COMPENSATION**
Electrical type sensor

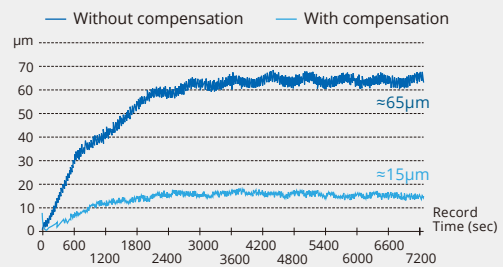

With compensation, the displacement of tool tip is reduced from 65µm to 15µm.

ACCURACY IMPROVED 5~6 TIMES!



Spindle Vibration Supervision

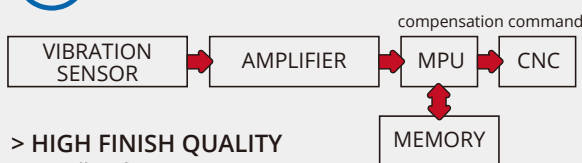

- > **HIGH FINISH QUALITY**
Spindle Life Time
- > **LONGER LIFE TIME**
Wear reduction on spindle bearings and tools
- > **EASY FOR MAINTENANCE**
Up to 12000 abnormal vibration data recording

Three Levels for Spindle Vibration Monitoring

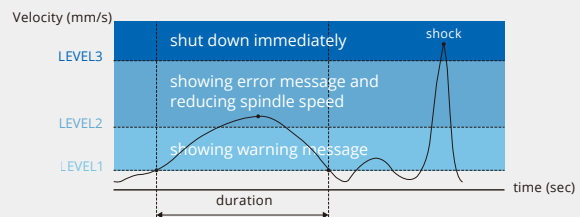

INTELLIGENT MONITORING SYSTEM

The future of manufacturing depends on optimized intelligent production. To gain an edge on the competition, embracing smart manufacturing is the best way to stay ahead of the curve. To deliver agile smart machining, and that all-important competitive edge, we have created ART™, an intelligent monitoring system that enables 24/7 operations and eliminates unexpected downtime. ART™ monitors all wearing components, energy consumption, and fluids such as lubricant and coolant, to supply real-time status updates on the machine and its components, and to pre-empt future issues.

Utilizing ART™ in daily operations immediately improves production efficiency by empowering machinists to make informed decisions. Moreover, ART™ gives manufacturers the reassurance required to embrace automation solutions, by delivering vital oversight through total operational transparency.

ART™ framework

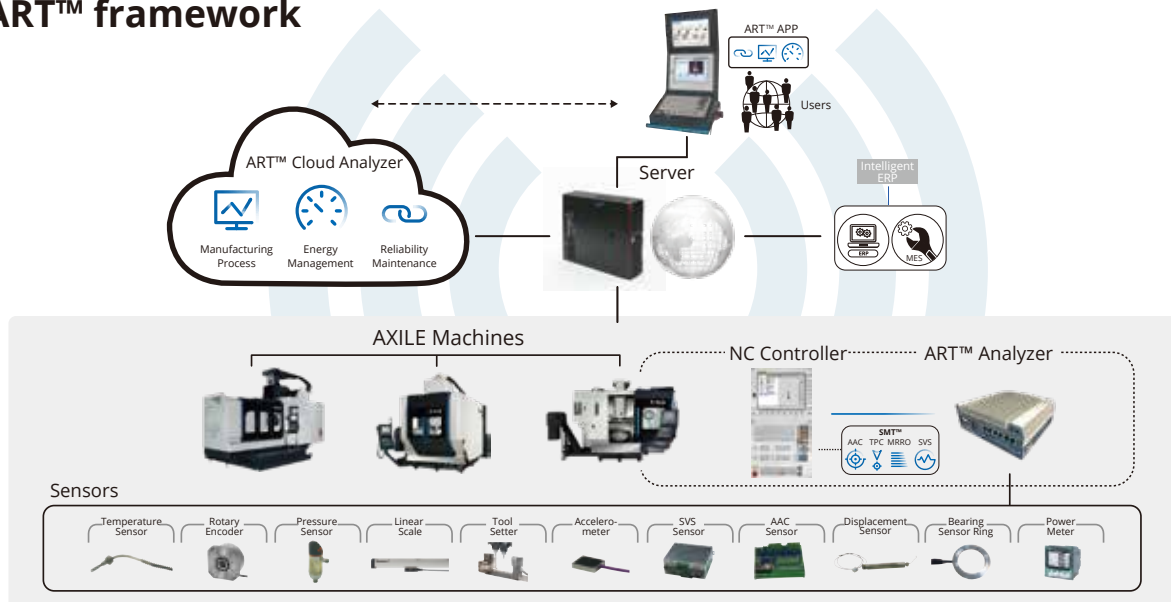

The Core Functions to Boost Productivity & Profitability

Manufacturing Process (MP)

Unexpected downtime is the enemy of profitability. ART™ delivers machine components diagnosis, machine lifetime estimation, and consumable supplies monitoring to prevent machine failure and eliminate unplanned downtime.

Energy Management (EM)

Every penny counts. ART™ enables manufacturers to monitor their power consumption, to identify ways to maximize energy efficiency and reduce expenditure.

Reliability Maintenance (RM)

Knowledge is power. ART™ achieves superior data collection and analytics on machine status and utilization rates, to deliver real-time information for optimized production strategies.

Intelligent Management (IM)

ART™ provides analytic information for managers to understand the machine performance and take the immediate actions to optimize the machine capability.

Industry 4.0 Solutions to Intelligent Machine

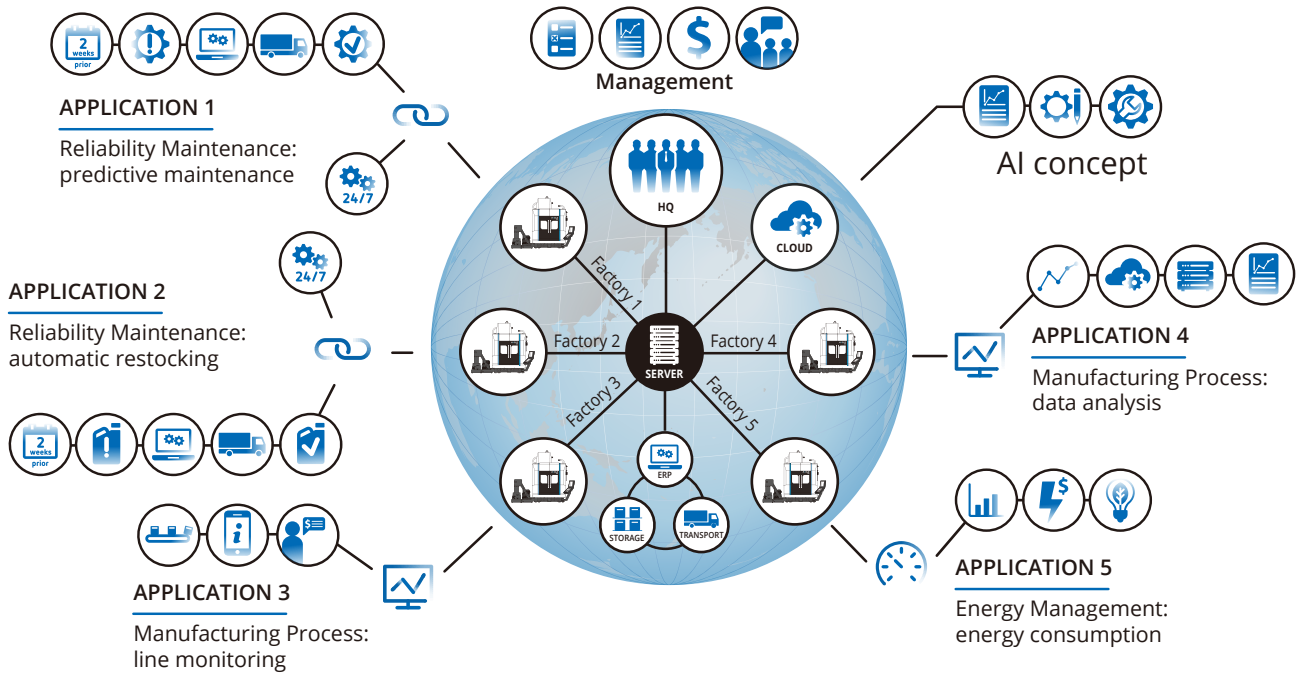

How ART™ Brings Production Benefits

- > Clearly displays machine status, for quick decision-making
- > Maximizes machine accessibility and utilization, for optimized production
- > Provides real-time notification of abnormal conditions, for swift intervention
- > Gives machinists the information required to optimize removal rates and machine lifetime

How ART™ Brings Maintenance & Service Benefits

- > Delivers pre-emptive error messages prior to breakdown, to eliminate unexpected downtime
- > Decreases service expenses, by precisely identifying the issue
- > Enhances service efficiency, by recommending appropriate action
- > Reduces spare parts inventory, by highlighting exactly what is needed and when
- > Automatically orders new parts, by linking to online purchasing system
- > Allows machines and equipment to remain on stand-by, always ready to work

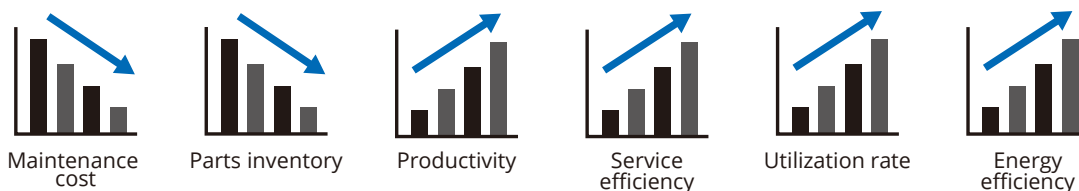

MOTORIZED PALLET CHANGER (MPC)

MPC increase autonomy and flexibility

Defined as extra large size of 5 axis machining center, DC12's MPC solutions exchange raw and finished workpieces between the machine and a separate holding area. It can accommodate 4 pallets for overall efficiency and productivity. With a maximum table loading weight of 2.3 tonnes and maximum diameter of 2,200 mm X 1,200 mm, DC12 is perfect for application in aerospace, power generation as well as mold & die industry.



DC12 MPC

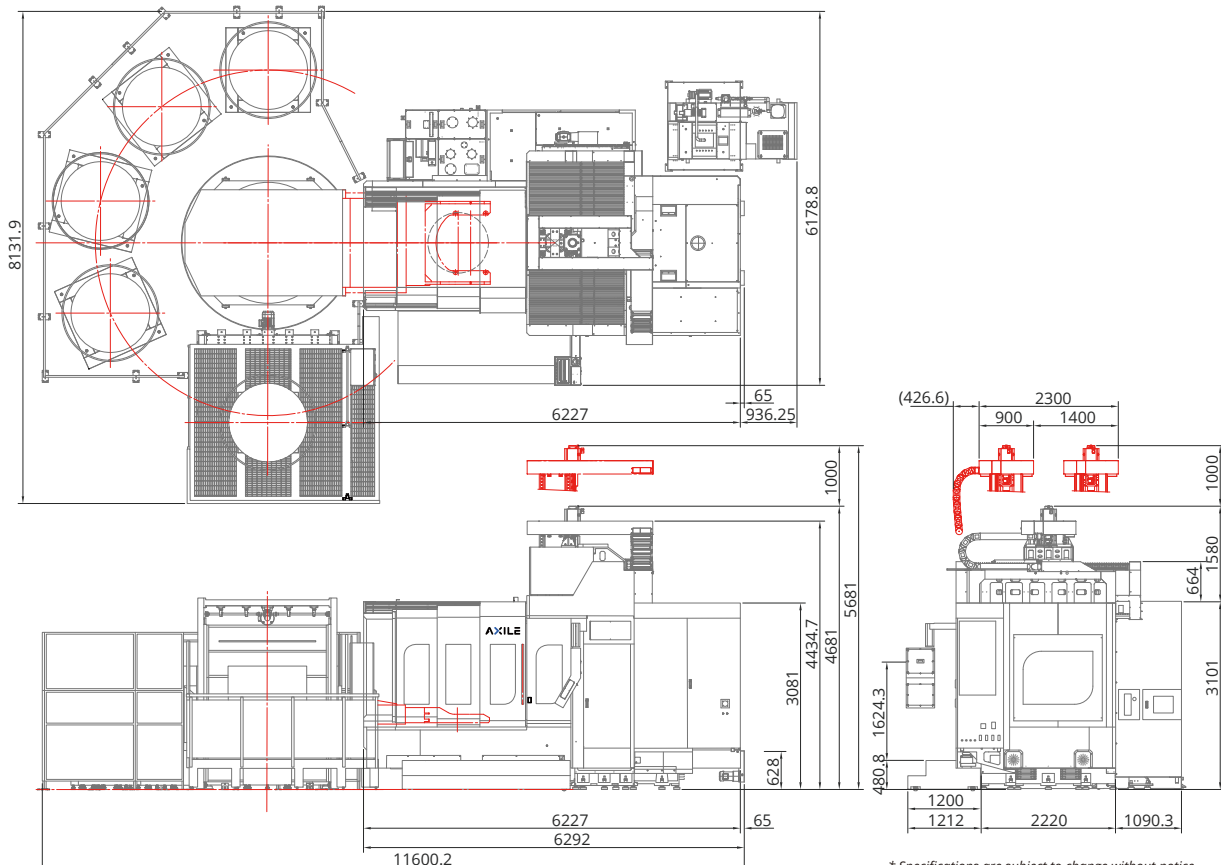

* Specifications are subject to change without notice.

LAYOUT AND WORKSPACE

DC12

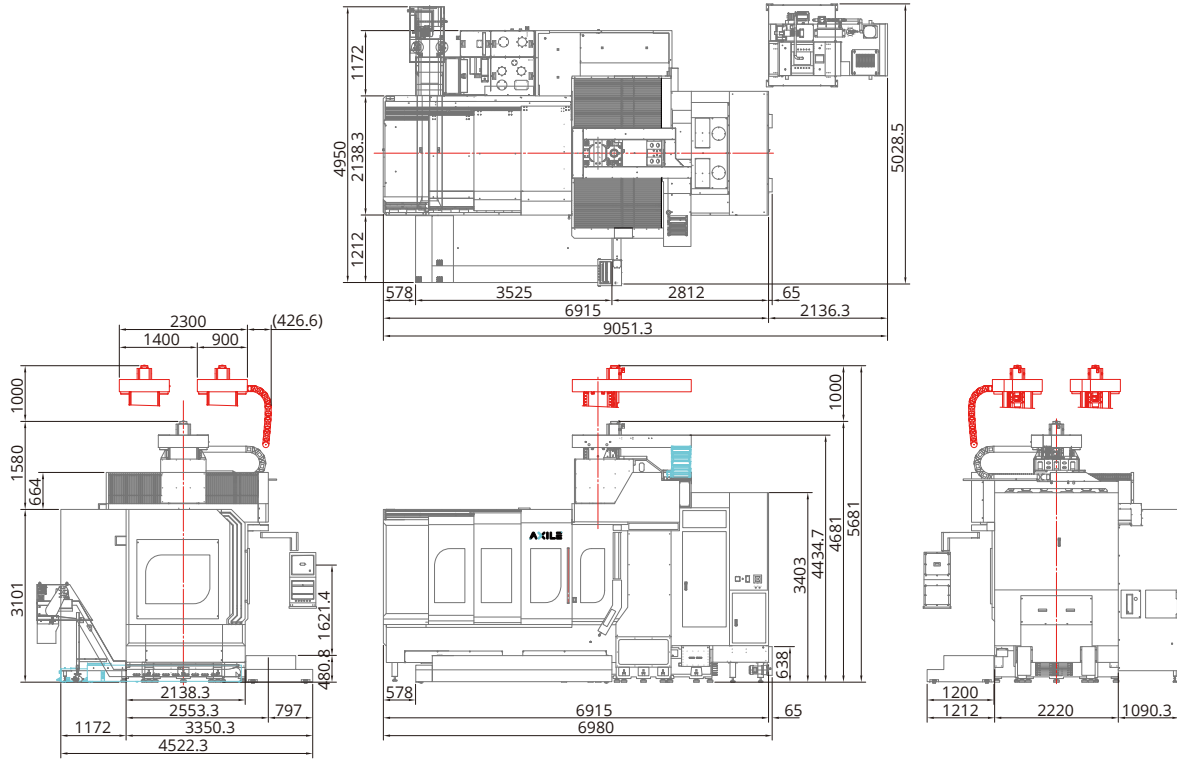

INTERFERENCE

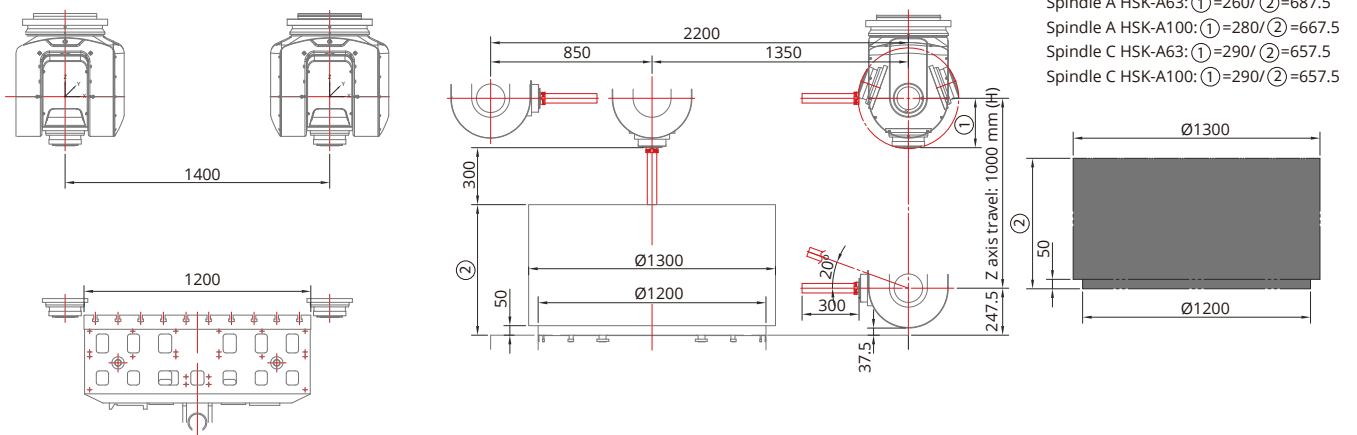

TECHNICAL DATA

COMMON DATA FOR DC12

TABLE		
Table size	2200x1200 mm	86.6x47.2 in
Maximum table load	2500 kg	5511 lbs
Rotary table top diameter	Ø1200 mm	Ø47.2 in
Total number of hydraulic and pneumatic ports	4	
LINEAR AXES		
X travel	2200 mm	86.6 in
Y travel	1400 mm	55.1 in
Z travel	1000 mm	39.4 in
Max feedrate X/Y/Z	36 m/min	1417 in/min
Guideways type	Roller	
Guideways size X/Y/Z	55/55/45 mm	2.1/2.1/1.7 in
ROTARY AXES		
Swiveling axis B - Head	±110 deg	
Rotary axis C - Table	360 deg	
Max speed axis B	100 rpm	
Max speed axis C	100 rpm	
SPINDLE K		
Spindle speed	20000 rpm(std) ; 16000 rpm(opt)	
Tool shank	HSK-A63(std) ; HSK-A100(opt)	
Power S1/S6-40%	45/45 kW(std)	60/60 hp(std)
	40/40 kW(opt)	53/53 hp(opt)
Torque S1/S6-40%	130/160 Nm(std)	95.9/118 Ft/lbs(std)
	150/180 Nm(opt)	110.6/132.7 Ft/lbs(opt)
SPINDLE T		
Spindle speed	20000 rpm(std) ; 16000 rpm(opt)	
Tool shank	HSK-A63(std) ; HSK-A100(opt)	
Power S1/S6-40%	60/65 kW(std)	80.4/87.1 hp(std)
	46/55 kW(opt)	61.6/73.7 hp(opt)
Torque	120/151 Nm(std)	88.5/111.3 Ft/lbs(std)
	174/241 Nm(opt)	128.3/177.7 Ft/lbs(opt)
MEASURING FEEDBACK		
Linear axes type	Linear scale	
Linear axes resolution	0.1 µm	
Rotary axes type	Rotary scale	
Rotary axis accuracy	±5"	
TOOL CHANGER		
Tool shank	HSK-A63(std) ; HSK-A100(opt)	
ATC type	Arm type	
Magazine positions	90T(std)/120T(opt) ; 60T(opt)	
Maximum tool length	500 mm	19.7 in
Maximum tool diameter	75 mm(std) ; 125 mm(opt)	3 in(std) ; 4.9 in(opt)
Maximum tool diameter (with adjacent pot empty)	150 mm(std) ; 229 mm(opt)	5.9 in(std) ; 9 in(opt)
Maximum tool weight	7 kg(std) ; 15 kg(opt)	15.4 lbs(std) ; 33.1 lbs(opt)
Maximum loading weight	450 kg(std) ; 600 kg(opt)	992.1 lbs(std) ; 1322.8 lbs(opt)

* Specifications are subject to change without notice.

ACCURACY (VDI/DGQ 3441)		
Positioning	0.005 mm	0.0002 in
Repeatability	0.005 mm	0.0002 in
STANDARD THROUGH COOLANT SUPPLY (STD)		
High pressure pump	40 bar	580 psi
OPTIONAL THROUGH COOLANT SUPPLY (OPT)		
High pressure pump	70 bar	580/1015 psi
CONTROL UNIT		
Heidenhain	TNC 640	
Siemens	840D SL/Sinumerik one	
Fanuc	31i-B5 Plus	
DIMENSION		
Length	7000 mm	23 Ft
Width	5100 mm	16.7 Ft
Height	5700 mm	18.7 Ft
Weight	28000 kg	61730 lbs
Floor Space	7000x5100 mm	23x16.7 Ft

* Specifications are subject to change without notice.





AXILE MACHINE

E info@axilemachine.com

W www.axilemachine.com.

©2021 AXILE. All rights reserved.